

Part 5 — Percolation approaches to disease spread

Joel C. Miller & Tom Hladish

18–20 July 2018

SIR and percolation

SIS disease

References

Percolation

We are going to explore a relationship between SIR disease and percolation.

This will lead to methods to

- ▶ predict epidemic probability from a single infection.
- ▶ predict final size of an epidemic.
- ▶ predict the dynamics of an epidemic.

Recall SIR behavior

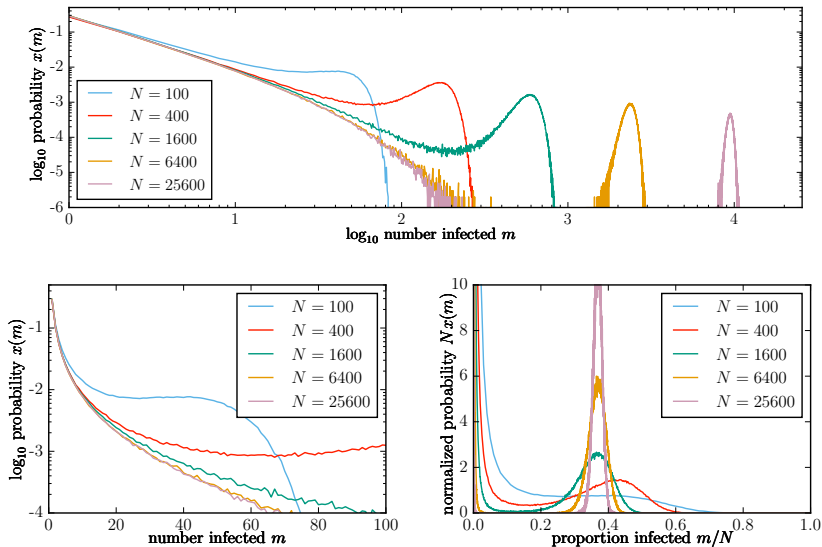

Modified model

We have a network

- ▶ An edge represents a potential transmission path (unweighted, bidirectional).

Modified model

We have a network

- ▶ An edge represents a potential transmission path (unweighted, bidirectional).
- ▶ An infected node remains infected for a single time step.

Modified model

We have a network

- ▶ An edge represents a potential transmission path (unweighted, bidirectional).
- ▶ An infected node remains infected for a single time step.
- ▶ An infected node transmits to a neighbor with probability p .

Modified model

We have a network

- ▶ An edge represents a potential transmission path (unweighted, bidirectional).
- ▶ An infected node remains infected for a single time step.
- ▶ An infected node transmits to a neighbor with probability p .
- ▶ **Warning** — no longer assuming continuous time

Modeling Disease Spread in a network



Modeling Disease Spread in a network

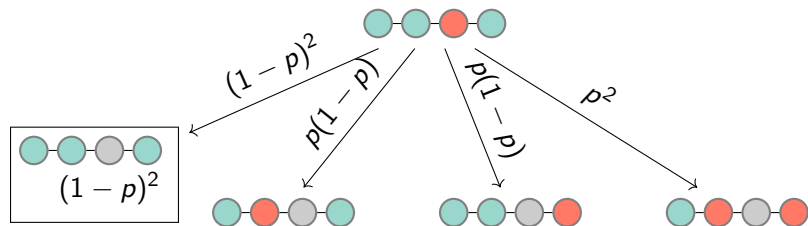

Modeling Disease Spread in a network

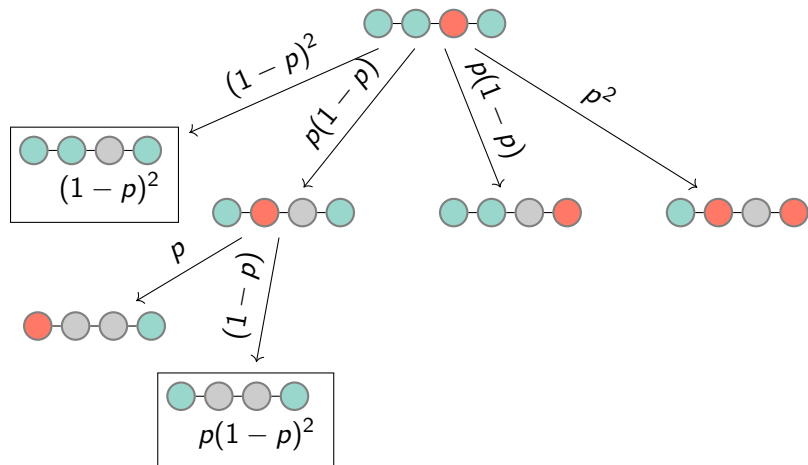

Modeling Disease Spread in a network

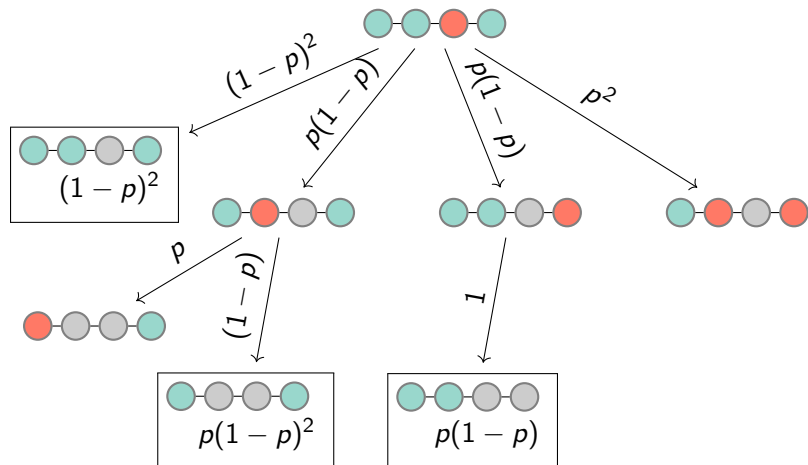

Modeling Disease Spread in a network

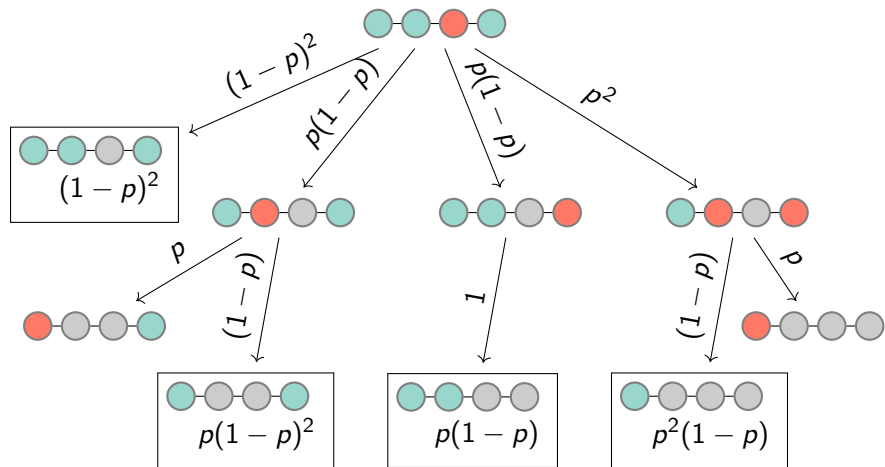

Modeling Disease Spread in a network

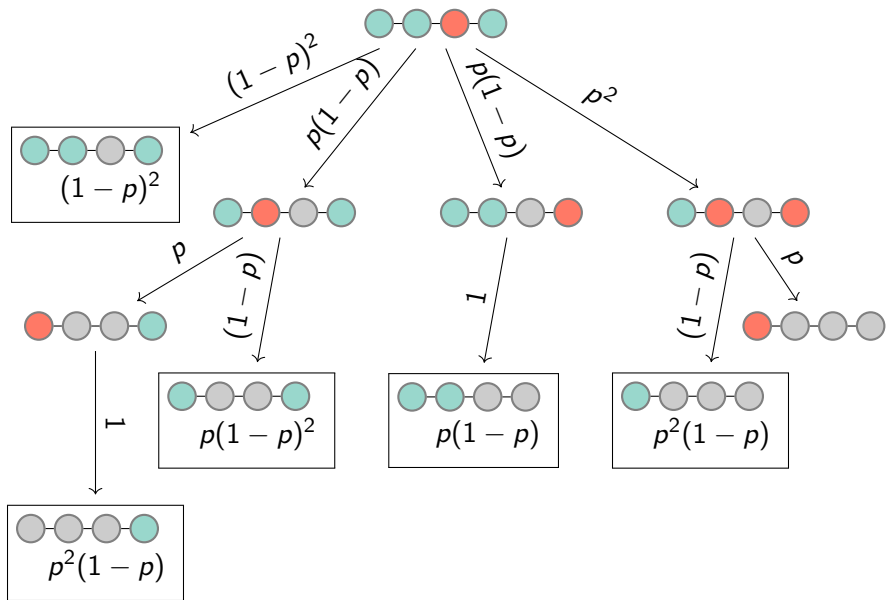

Modeling Disease Spread in a network

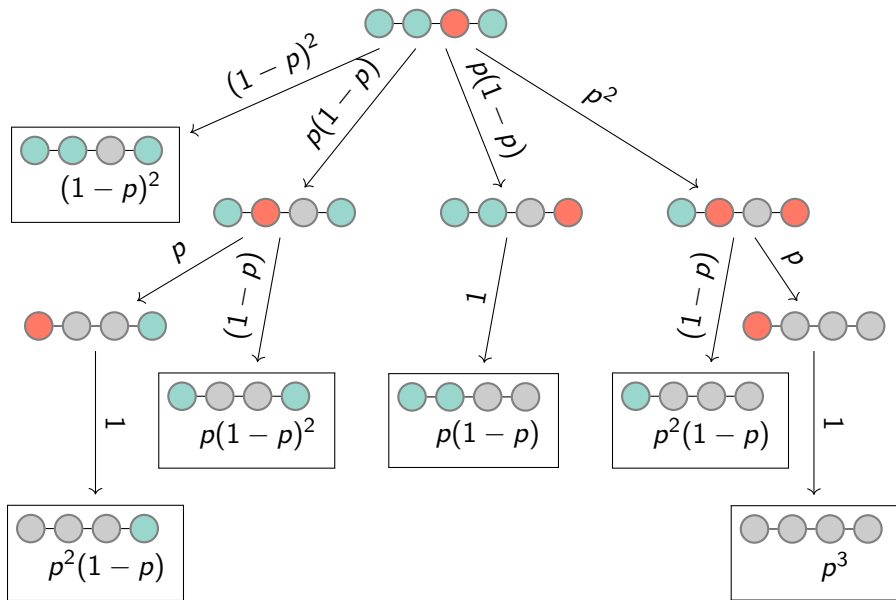

Alternative perspective

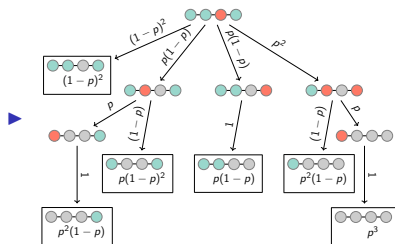

At each step, if there is an edge to cross, it is crossed with probability p . No edge is ever crossed twice.

Alternative perspective

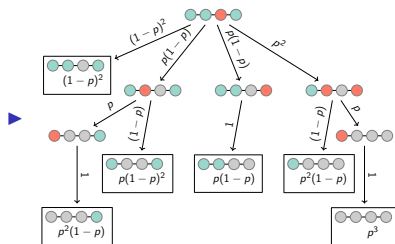

- ▶ It is equivalent to decide in advance whether the edges will be crossed if encountered.

At each step, if there is an edge to cross, it is crossed with probability p . No edge is ever crossed twice.

Alternative perspective

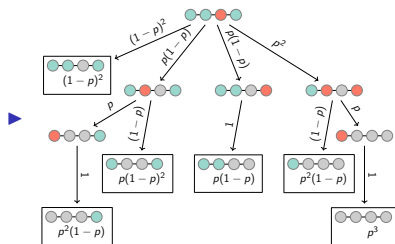

At each step, if there is an edge to cross, it is crossed with probability p . No edge is ever crossed twice.

- It is equivalent to decide in advance whether the edges will be crossed if encountered.

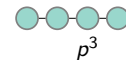
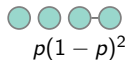
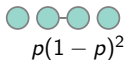
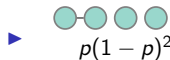
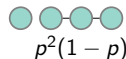
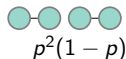
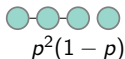
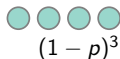

Alternative perspective

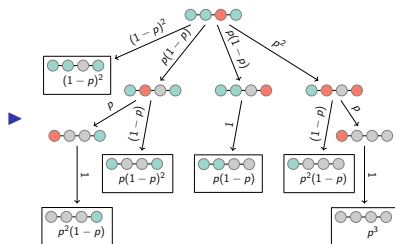

At each step, if there is an edge to cross, it is crossed with probability p . No edge is ever crossed twice.

- It is equivalent to decide in advance whether the edges will be crossed if encountered.

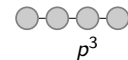
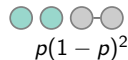
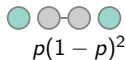
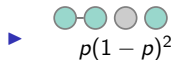
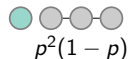
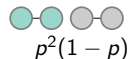
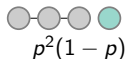

Percolation in different size networks

Comparison of largest (red) and second largest (blue) components in different size networks below and above percolation threshold.

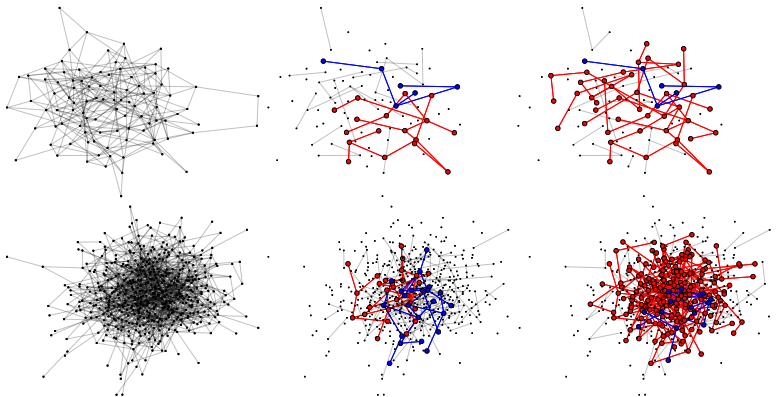

- ▶ Below threshold largest and second largest in a network are about the same size as each other and similar size in both networks
- ▶ Above threshold largest is proportional to network size.

More detailed comparison of network size

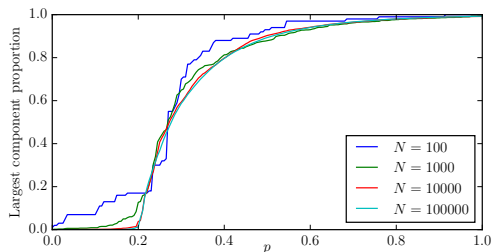

- ▶ Above the threshold, an epidemic occurs if the initial node is in the giant component.
- ▶ The entire component containing the index is infected.
- ▶ For a large network with given p , the giant component's size is remarkably consistent. So the probability of an epidemic equals the proportion infected.

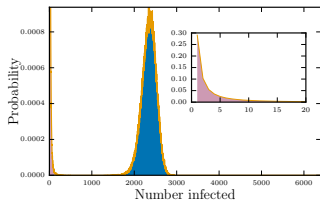
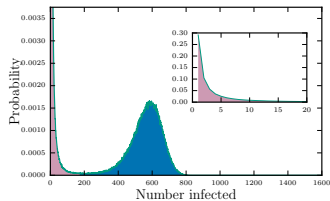
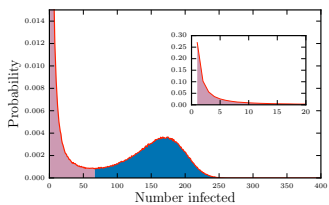
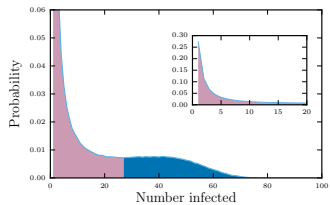

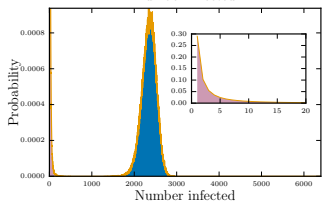
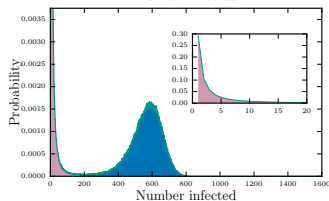
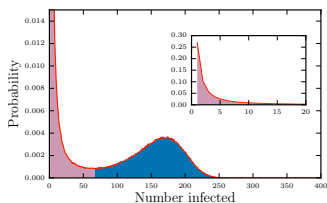
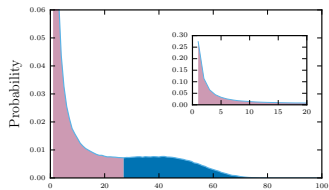

N	\mathcal{P}	\mathcal{A}
100	0.237	0.423
400	0.340	0.387
1600	0.339	0.350
6400	0.365	0.366
25600	0.368	0.368

Now return back to transmitting with rate β and recovering with rate γ .

Transmission probability

- ▶ We'll want to know the probability an infected node v transmits to its neighbor u (assuming v is infected).

Transmission probability

- ▶ We'll want to know the probability an infected node v transmits to its neighbor u (assuming v is infected).
- ▶ Transmission is at rate β , and recovery is at rate γ . The probability of transmitting before recovering is $\beta/(\beta + \gamma)$.

Transmission probability

- ▶ We'll want to know the probability an infected node v transmits to its neighbor u (assuming v is infected).
- ▶ Transmission is at rate β , and recovery is at rate γ . The probability of transmitting before recovering is $\beta/(\beta + \gamma)$.
- ▶ Note: v transmitting to u and to w are correlated events (both depend on duration of v 's infection), but transmissions from different nodes to a single node are independent.

Directed percolation analogy

Given a network G , I want to simulate the spread of an SIR disease with given β and γ

- ▶ I use Tom as a random number generator.

Directed percolation analogy

Given a network G , I want to simulate the spread of an SIR disease with given β and γ

- ▶ I use Tom as a random number generator.
 - ▶ When a node u becomes infected, I ask Tom: “how long will its infection last?”
 - ▶ Then for each neighbor v I ask “will u transmit to v ? When?”

Directed percolation analogy

Given a network G , I want to simulate the spread of an SIR disease with given β and γ

- ▶ I use Tom as a random number generator.
 - ▶ When a node u becomes infected, I ask Tom: “how long will its infection last?”
 - ▶ Then for each neighbor v I ask “will u transmit to v ? When?”
- ▶ Tom decides he doesn't like the rush to generate a random number on the fly. So he does it in advance.

Directed percolation analogy

Given a network G , I want to simulate the spread of an SIR disease with given β and γ

- ▶ I use Tom as a random number generator.
 - ▶ When a node u becomes infected, I ask Tom: “how long will its infection last?”
 - ▶ Then for each neighbor v I ask “will u transmit to v ? When?”
- ▶ Tom decides he doesn't like the rush to generate a random number on the fly. So he does it in advance.
 - ▶ For each node Tom assigns the duration its infection will last if infected.
 - ▶ Once the duration is chosen, Tom decides which neighbors it will transmit to and how long it will take.
 - ▶ Then he reports those to me when I ask.

Directed percolation analogy

Given a network G , I want to simulate the spread of an SIR disease with given β and γ

- ▶ I use Tom as a random number generator.
 - ▶ When a node u becomes infected, I ask Tom: “how long will its infection last?”
 - ▶ Then for each neighbor v I ask “will u transmit to v ? When?”
- ▶ Tom decides he doesn't like the rush to generate a random number on the fly. So he does it in advance.
 - ▶ For each node Tom assigns the duration its infection will last if infected.
 - ▶ Once the duration is chosen, Tom decides which neighbors it will transmit to and how long it will take.
 - ▶ Then he reports those to me when I ask.
- ▶ Is it possible for me to know whether he is calculating in advance or not?

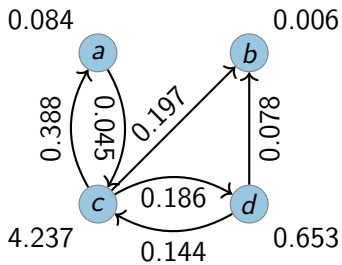
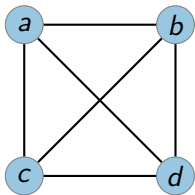

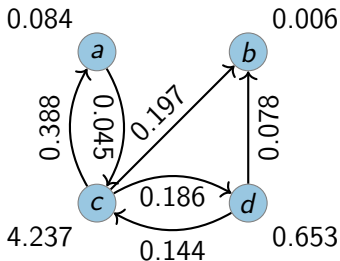
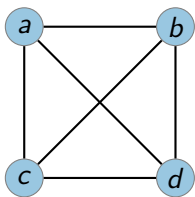

Every number that Tom gives me is a random number that is generated independently of every other number. It doesn't matter when he generates it.

Typical structure

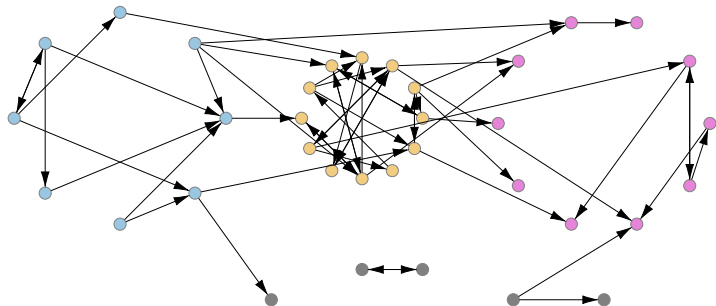

Directed Percolation Equivalence

The following processes produce **indistinguishable** output:

- ▶ Standard epidemic simulation:

Directed Percolation Equivalence

The following processes produce **indistinguishable** output:

- ▶ Standard epidemic simulation:
 - ▶ Take a network G .
 - ▶ Choose an initial infected individual.
 - ▶ Allow edges to transmit until the **random time** the individual recovers.

Directed Percolation Equivalence

The following processes produce **indistinguishable** output:

- ▶ Standard epidemic simulation:
 - ▶ Take a network G .
 - ▶ Choose an initial infected individual.
 - ▶ Allow edges to transmit until the **random time** the individual recovers.
- ▶ Percolation-based simulation:

Directed Percolation Equivalence

The following processes produce **indistinguishable** output:

- ▶ Standard epidemic simulation:
 - ▶ Take a network G .
 - ▶ Choose an initial infected individual.
 - ▶ Allow edges to transmit until the **random time** the individual recovers.
- ▶ Percolation-based simulation:
 - ▶ Take a network G .

Directed Percolation Equivalence

The following processes produce **indistinguishable** output:

- ▶ Standard epidemic simulation:
 - ▶ Take a network G .
 - ▶ Choose an initial infected individual.
 - ▶ Allow edges to transmit until the **random time** the individual recovers.
- ▶ Percolation-based simulation:
 - ▶ Take a network G .
 - ▶ Generate a new directed network H :

Directed Percolation Equivalence

The following processes produce **indistinguishable** output:

- ▶ Standard epidemic simulation:
 - ▶ Take a network G .
 - ▶ Choose an initial infected individual.
 - ▶ Allow edges to transmit until the **random time** the individual recovers.
- ▶ Percolation-based simulation:
 - ▶ Take a network G .
 - ▶ Generate a new directed network H :
 - ▶ For each individual u , assign a duration d of infection.
 - ▶ For each edge from u , determine delay \hat{t} until transmitting.
 - ▶ If $\hat{t} < d$, place directed edge into network with associated time.

Directed Percolation Equivalence

The following processes produce **indistinguishable** output:

- ▶ Standard epidemic simulation:
 - ▶ Take a network G .
 - ▶ Choose an initial infected individual.
 - ▶ Allow edges to transmit until the **random time** the individual recovers.
- ▶ Percolation-based simulation:
 - ▶ Take a network G .
 - ▶ Generate a new directed network H :
 - ▶ For each individual u , assign a duration d of infection.
 - ▶ For each edge from u , determine delay \hat{t} until transmitting.
 - ▶ If $\hat{t} < d$, place directed edge into network with associated time.
 - ▶ Choose an initial infected individual.
 - ▶ Trace the disease spread following edges in H , transmitting after the given time.

Comments on directed percolation

- ▶ Directed percolation can be used more generally when there are other sources of heterogeneity in infectiousness and/or susceptibility.
- ▶ The eventually infected nodes are exactly those nodes in the out-component of the index case.
- ▶ The probability a random node is infected follows from the size of its in-component.

Typical structure

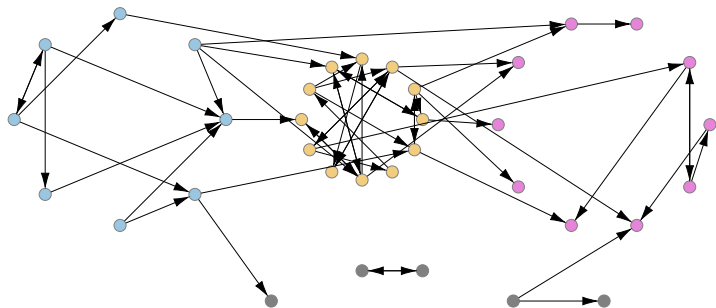

- ▶ We can understand the dynamics with a “bowtie” diagram.

Typical structure

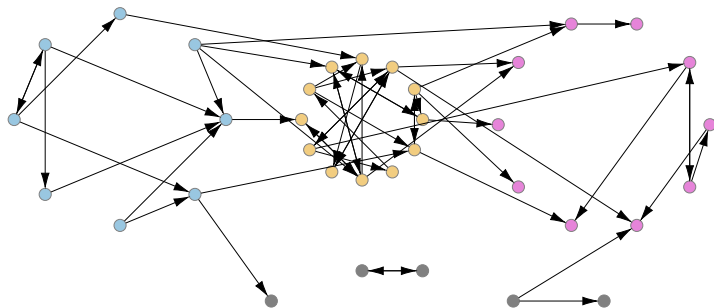

- ▶ We can understand the dynamics with a “bowtie” diagram.
- ▶ Above a threshold there is a Giant Strongly Connected Component H_{SCC}

Typical structure

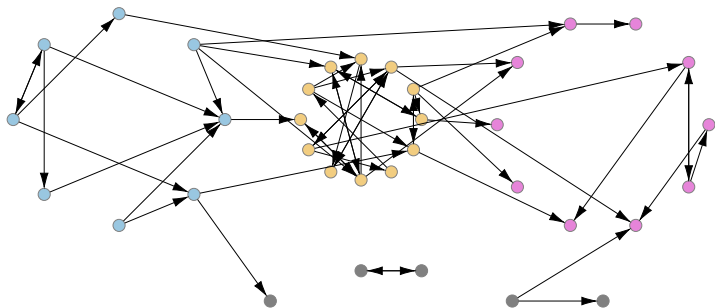

- ▶ We can understand the dynamics with a “bowtie” diagram.
- ▶ Above a threshold there is a Giant Strongly Connected Component H_{SCC}
- ▶ It has an in-component H_{IN} and an out-component H_{OUT} .

Typical structure

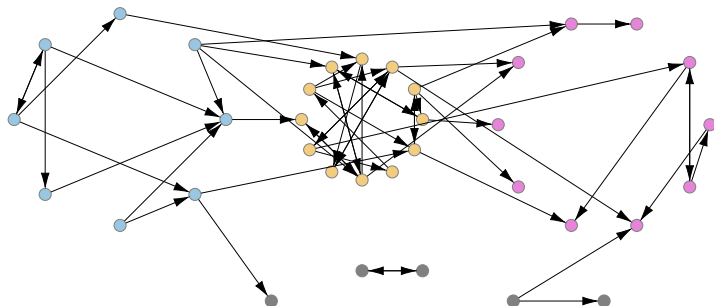

- ▶ We can understand the dynamics with a “bowtie” diagram.
- ▶ Above a threshold there is a Giant Strongly Connected Component H_{SCC}
- ▶ It has an in-component H_{IN} and an out-component H_{OUT} .
- ▶ If the index case is in H_{IN} or H_{SCC} then all of H_{SCC} and H_{OUT} are eventually infected.

Typical structure

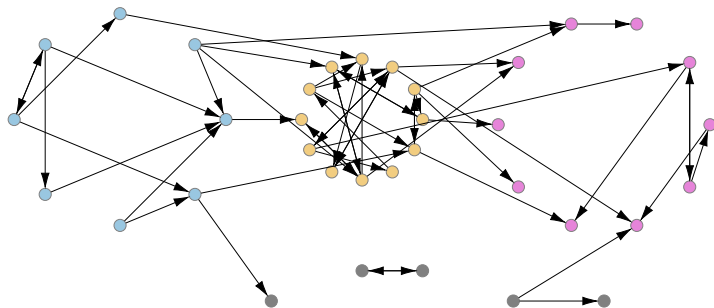

- ▶ We can understand the dynamics with a “bowtie” diagram.
- ▶ Above a threshold there is a Giant Strongly Connected Component H_{SCC}
- ▶ It has an in-component H_{IN} and an out-component H_{OUT} .
- ▶ If the index case is in H_{IN} or H_{SCC} then all of H_{SCC} and H_{OUT} are eventually infected.
- ▶ So Epidemic Probability $\mathcal{P} = \mathbb{E}(|H_{IN} \cup H_{SCC}|)/N$ and Attack rate $\mathcal{A} = \mathbb{E}(|H_{SCC} \cup H_{OUT}|)/N$.

Some consequences

The dynamic process of the epidemic is now encoded in a static network H . Studying H gives us some insight into what is happening.

Some consequences

The dynamic process of the epidemic is now encoded in a static network H . Studying H gives us some insight into what is happening.

- ▶ There is a symmetry between epidemic probability and epidemic final size.

Some consequences

The dynamic process of the epidemic is now encoded in a static network H . Studying H gives us some insight into what is happening.

- ▶ There is a symmetry between epidemic probability and epidemic final size.
- ▶ Because edges out of a node are correlated and edges in to a node are not, $\overline{\mathcal{P}} \neq \mathcal{A}$.

Some consequences

The dynamic process of the epidemic is now encoded in a static network H . Studying H gives us some insight into what is happening.

- ▶ There is a symmetry between epidemic probability and epidemic final size.
- ▶ Because edges out of a node are correlated and edges in to a node are not, $\overline{\mathcal{P}} \neq \mathcal{A}$.
- ▶ The probability of an epidemic is the proportion of nodes from which there is a long chain of transmissions in H .

Some consequences

The dynamic process of the epidemic is now encoded in a static network H . Studying H gives us some insight into what is happening.

- ▶ There is a symmetry between epidemic probability and epidemic final size.
- ▶ Because edges out of a node are correlated and edges in to a node are not, $\overline{\mathcal{P}} \neq \mathcal{A}$.
- ▶ The probability of an epidemic is the proportion of nodes from which there is a long chain of transmissions in H .
- ▶ The final size of an epidemic with a **very small** initial proportion infected is the proportion of nodes which are the target of a long chain of transmissions in H .

SIR epidemics in Configuration Model networks

- ▶ Consider a Configuration Model network in which we infect a (probably small) fraction of the population ρ .
- ▶ Allow the SIR disease to spread.
- ▶ We assume ρN is large enough that stochastic die-out does not play a major role.

Recall our key questions

For SIR:

- ▶ \mathcal{P} , the probability of an epidemic.
- ▶ \mathcal{A} , the “attack rate”: the fraction infected if an epidemic happens (better named the attack ratio).
- ▶ \mathcal{R}_0 , the average number of infections caused by those infected early in the epidemic.
- ▶ $I(t)$, the time course of the epidemic.

For SIS:

- ▶ \mathcal{P}
- ▶ $I(\infty)$, the equilibrium level of infection
- ▶ \mathcal{R}_0
- ▶ $I(t)$

\mathcal{R}_0 calculation

For SIR disease:

\mathcal{R}_0 calculation

For SIR disease:

- ▶ The probability a newly infected individual has degree k is $P_n(k)$.

\mathcal{R}_0 calculation

For SIR disease:

- ▶ The probability a newly infected individual has degree k is $P_n(k)$.
- ▶ The expected number of infections it causes given k is $(k-1)\frac{\beta}{\beta+\gamma}$ [it cannot reinfect the source of its infection].
- ▶ So

$$\mathcal{R}_0 = \mathbb{E}(\text{number infections caused} | \text{infected early})$$

\mathcal{R}_0 calculation

For SIR disease:

- ▶ The probability a newly infected individual has degree k is $P_n(k)$.
- ▶ The expected number of infections it causes given k is $(k-1)\frac{\beta}{\beta+\gamma}$ [it cannot reinfect the source of its infection].
- ▶ So

$$\begin{aligned}\mathcal{R}_0 &= \mathbb{E}(\text{number infections caused}|\text{infected early}) \\ &= \sum_k P(k|\text{infected early})\mathbb{E}(\text{number infections}|k)\end{aligned}$$

\mathcal{R}_0 calculation

For SIR disease:

- ▶ The probability a newly infected individual has degree k is $P_n(k)$.
- ▶ The expected number of infections it causes given k is $(k-1)\frac{\beta}{\beta+\gamma}$ [it cannot reinfect the source of its infection].
- ▶ So

$$\begin{aligned}\mathcal{R}_0 &= \mathbb{E}(\text{number infections caused} | \text{infected early}) \\ &= \sum_k P(k | \text{infected early}) \mathbb{E}(\text{number infections} | k) \\ &= \sum_k P_n(k) (k-1) \frac{\beta}{\beta+\gamma}\end{aligned}$$

\mathcal{R}_0 calculation

For SIR disease:

- ▶ The probability a newly infected individual has degree k is $P_n(k)$.
- ▶ The expected number of infections it causes given k is $(k-1)\frac{\beta}{\beta+\gamma}$ [it cannot reinfect the source of its infection].
- ▶ So

$$\begin{aligned}\mathcal{R}_0 &= \mathbb{E}(\text{number infections caused} | \text{infected early}) \\ &= \sum_k P(k | \text{infected early}) \mathbb{E}(\text{number infections} | k) \\ &= \sum_k P_n(k) (k-1) \frac{\beta}{\beta+\gamma} \\ &= \frac{\beta}{\beta+\gamma} \sum_k \frac{kP(k)(k-1)}{\langle K \rangle}\end{aligned}$$

\mathcal{R}_0 calculation

For SIR disease:

- ▶ The probability a newly infected individual has degree k is $P_n(k)$.
- ▶ The expected number of infections it causes given k is $(k-1)\frac{\beta}{\beta+\gamma}$ [it cannot reinfect the source of its infection].
- ▶ So

$$\begin{aligned}\mathcal{R}_0 &= \mathbb{E}(\text{number infections caused} | \text{infected early}) \\ &= \sum_k P(k | \text{infected early}) \mathbb{E}(\text{number infections} | k) \\ &= \sum_k P_n(k) (k-1) \frac{\beta}{\beta+\gamma} \\ &= \frac{\beta}{\beta+\gamma} \sum_k \frac{kP(k)(k-1)}{\langle K \rangle} \\ &= \frac{\beta}{\beta+\gamma} \frac{\langle K^2 - K \rangle}{\langle K \rangle}\end{aligned}$$

Recall our key questions

For SIR:

- ▶ \mathcal{P} , the probability of an epidemic.
- ▶ \mathcal{A} , the “attack rate”: the fraction infected if an epidemic happens (better named the attack ratio).
- ▶ \mathcal{R}_0 , the average number of infections caused by those infected early in the epidemic.
- ▶ $I(t)$, the time course of the epidemic.

For SIS:

- ▶ \mathcal{P}
- ▶ $I(\infty)$, the equilibrium level of infection
- ▶ \mathcal{R}_0
- ▶ $I(t)$

Changing the final size question

Instead of asking what proportion end up susceptible or recovered ask:

Changing the final size question

Instead of asking what proportion end up susceptible or recovered ask:

What is the probability a random node does not have a transmission path to it from one of the index nodes?

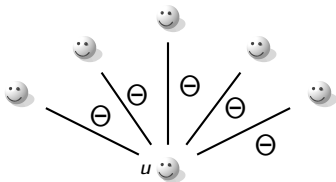

$$\Theta = P(v \text{ did not transmit to } u)$$

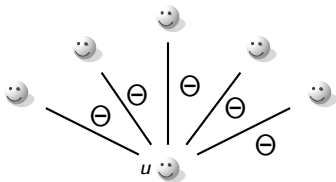

$$\Theta = P(v \text{ did not transmit to } u)$$

Probability a random degree k test individual is susceptible at the end is

$$(1 - \rho)\Theta^k$$

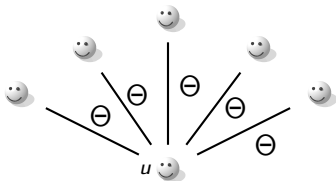

$$\Theta = P(v \text{ did not transmit to } u)$$

Probability a random ~~degree- k~~ test individual is susceptible at the end is

$$\frac{S}{N} = \sum_k P(k)(1 - \rho)\Theta^k$$

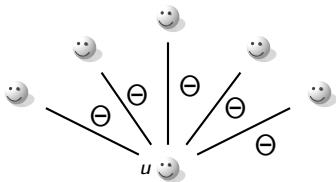

$$\Theta = P(v \text{ did not transmit to } u)$$

Probability a random ~~degree- k~~ test individual is susceptible at the end is

$$\frac{S}{N} = \sum_k P(k)(1 - \rho)\Theta^k = (1 - \rho)\psi(\Theta)$$

where

$$\psi(x) = \sum_k P(k)x^k$$

Finding Θ

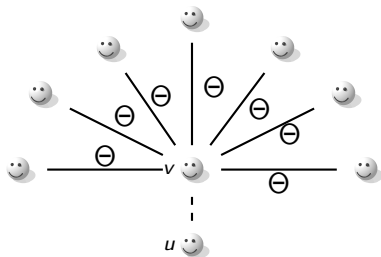

Probability a random degree k partner never infected is

$$(1 - \rho)\Theta^{k-1}$$

Finding Θ

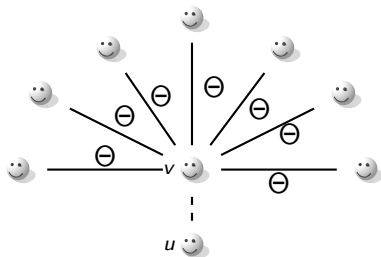

Probability a random ~~degree- k~~ partner never infected is

$$\phi_S = \sum_k P_n(k)(1 - \rho)\Theta^{k-1}$$

Finding Θ

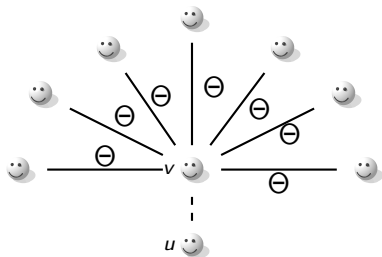

Probability a random ~~degree- k~~ partner never infected is

$$\phi_S = \sum_k \frac{kP(k)}{\langle K \rangle} (1 - \rho) \Theta^{k-1}$$

Finding Θ

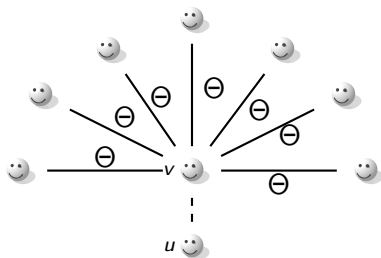

Probability a random **degree- k** partner never infected is

$$\phi_S = \sum_k \frac{kP(k)}{\langle K \rangle} (1 - \rho) \Theta^{k-1} = (1 - \rho) \frac{\psi'(\Theta)}{\langle K \rangle}$$

Finding Θ

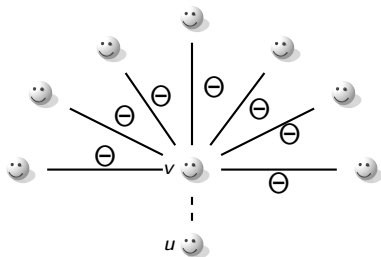

Probability a random ~~degree- k~~ partner never infected is

$$\phi_S = \sum_k \frac{kP(k)}{\langle K \rangle} (1 - \rho) \Theta^{k-1} = (1 - \rho) \frac{\psi'(\Theta)}{\langle K \rangle}$$

Given β and γ , partner does not transmit to u with probability

$$\Theta = \phi_S + \left(1 - \frac{\beta}{\beta + \gamma}\right) (1 - \phi_S)$$

Finding Θ

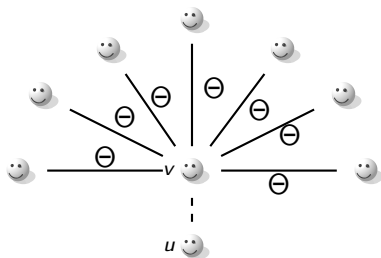

Probability a random ~~degree- k~~ partner never infected is

$$\phi_S = \sum_k \frac{kP(k)}{\langle K \rangle} (1 - \rho) \Theta^{k-1} = (1 - \rho) \frac{\psi'(\Theta)}{\langle K \rangle}$$

Given β and γ , partner does not transmit to u with probability

$$\Theta = \phi_S + \left(1 - \frac{\beta}{\beta + \gamma}\right) (1 - \phi_S) = 1 - \frac{\beta}{\beta + \gamma} + \frac{\beta}{\beta + \gamma} \frac{(1 - \rho) \psi'(\Theta)}{\langle K \rangle}$$

Final Size

So

$$\mathcal{A} = 1 - (1 - \rho)\psi(\Theta)$$

where

$$\Theta = \frac{\gamma}{\beta + \gamma} + \frac{\beta}{\beta + \gamma}(1 - \rho)\frac{\psi'(\Theta)}{\langle K \rangle}$$

Final Size

So

$$\mathcal{A} = 1 - (1 - \rho)\psi(\Theta)$$

where

$$\Theta = \frac{\gamma}{\beta + \gamma} + \frac{\beta}{\beta + \gamma}(1 - \rho)\frac{\psi'(\Theta)}{\langle K \rangle}$$

A more rigorous definition would be that Θ is the probability that the given edge isn't the final edge of a directed path from an index node to u in the percolated network H .

Recall our key questions

For SIR:

- ▶ \mathcal{P} , the probability of an epidemic.
- ▶ \mathcal{A} , the “attack rate”: the fraction infected if an epidemic happens (better named the attack ratio).
- ▶ \mathcal{R}_0 , the average number of infections caused by those infected early in the epidemic.
- ▶ $I(t)$, the time course of the epidemic.

For SIS:

- ▶ \mathcal{P}
- ▶ $I(\infty)$, the equilibrium level of infection
- ▶ \mathcal{R}_0
- ▶ $I(t)$

Finding $S(t)$ for SIR disease

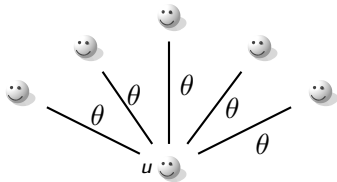

$$\theta(t) = P(v \text{ not yet transmitted to } u)$$

Finding $S(t)$ for SIR disease

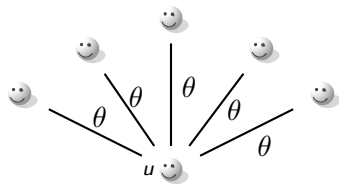

$$\theta(t) = P(v \text{ not yet transmitted to } u)$$

Probability a random degree k test individual still susceptible is

$$(1 - \rho)\theta(t)^k$$

Finding $S(t)$ for SIR disease

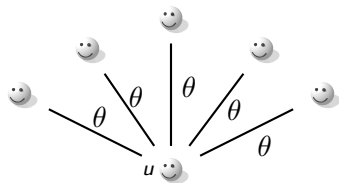

$$\theta(t) = P(v \text{ not yet transmitted to } u)$$

Probability a random ~~degree- k~~ test individual still susceptible is

$$\frac{S(t)}{N} = \sum_k P(k)(1 - \rho)\theta(t)^k$$

Finding $S(t)$ for SIR disease

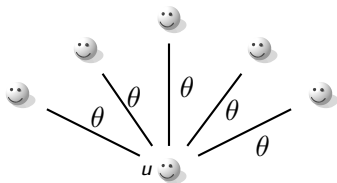

$$\theta(t) = P(v \text{ not yet transmitted to } u)$$

Probability a random ~~degree- k~~ test individual still susceptible is

$$\frac{S(t)}{N} = \sum_k P(k)(1 - \rho)\theta(t)^k = (1 - \rho)\psi(\theta(t))$$

where

$$\psi(x) = \sum_k P(k)x^k$$

How does θ evolve?

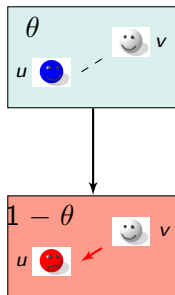

How does θ evolve?

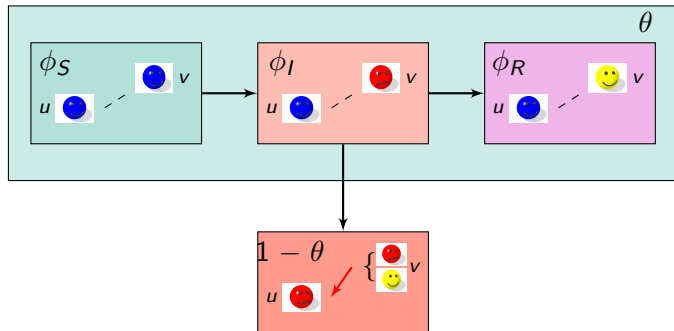

► $\theta = \phi_S + \phi_I + \phi_R.$

How does θ evolve?

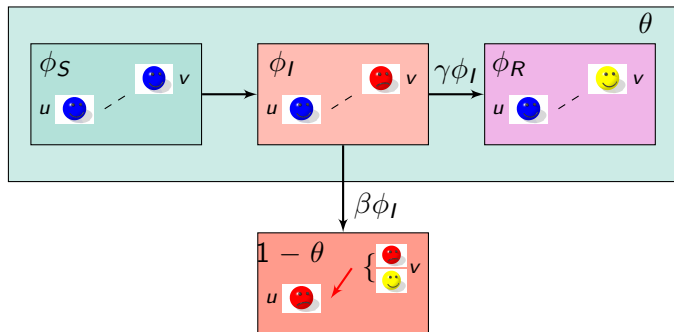

- ▶ $\theta = \phi_S + \phi_I + \phi_R.$
- ▶ $\dot{\theta} = -\beta\phi_I.$

How does θ evolve?

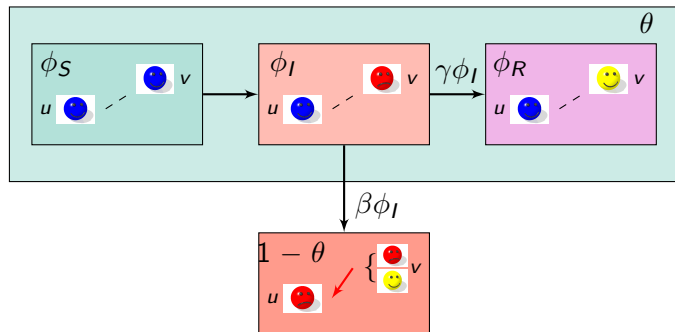

- ▶ $\theta = \phi_S + \phi_I + \phi_R$.
- ▶ $\dot{\theta} = -\beta\phi_I$.
- ▶ Our goal is to find ϕ_I in terms of θ .

Finding $\phi_R(t)$

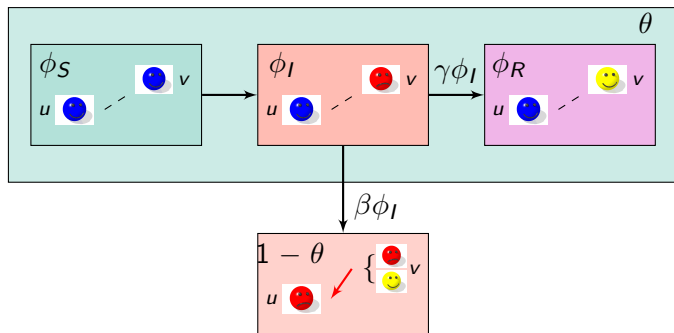

Because derivatives are proportional, $\phi_R = \frac{\gamma}{\beta}(1 - \theta)$

Finding $\phi_S(t)$

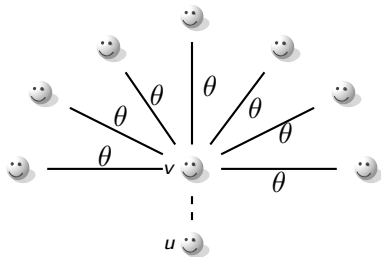

Probability a random degree k partner still susceptible is

$$(1 - \rho)\theta(t)^{k-1}$$

Finding $\phi_S(t)$

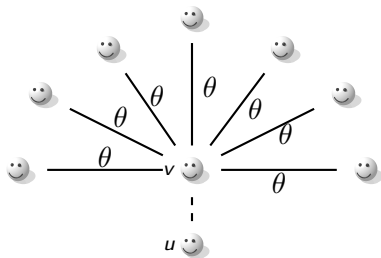

Probability a random ~~degree- k~~ partner still susceptible is

$$\phi_S(t) = \sum_k P_n(k) (1 - \rho) \theta(t)^{k-1}$$

Finding $\phi_S(t)$

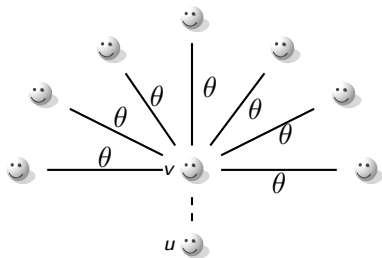

Probability a random ~~degree- k~~ partner still susceptible is

$$\phi_S(t) = \sum_k \frac{kP(k)}{\langle K \rangle} (1 - \rho)\theta(t)^{k-1}$$

Finding $\phi_S(t)$

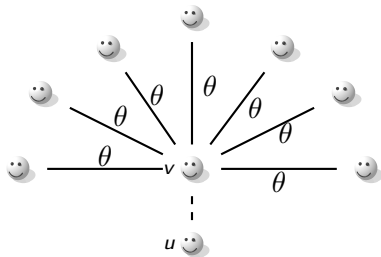

Probability a random ~~degree- k~~ partner still susceptible is

$$\phi_S(t) = \sum_k \frac{kP(k)}{\langle K \rangle} (1 - \rho)\theta(t)^{k-1} = (1 - \rho) \frac{\psi'(\theta)}{\langle K \rangle}$$

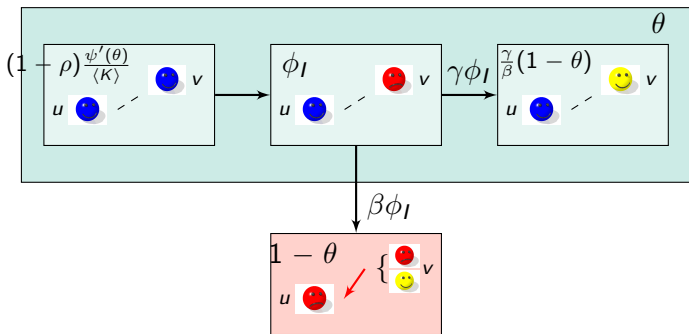

We have

$$\phi_I = \theta - \phi_S - \phi_R$$

$$\dot{\theta} = -\beta\phi_I$$

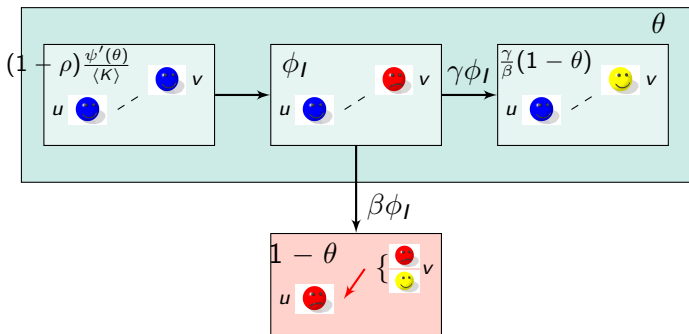

We have

$$\phi_I = \theta - \phi_S - \phi_R = \theta - \frac{(1 - \rho)\psi'(\theta)}{\langle K \rangle} - \frac{\gamma}{\beta}(1 - \theta)$$

$$\dot{\theta} = -\beta\phi_I$$

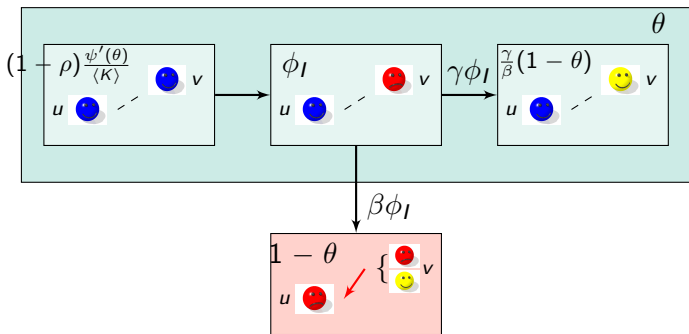

We have

$$\phi_I = \theta - \phi_S - \phi_R = \theta - \frac{(1-\rho)\psi'(\theta)}{\langle K \rangle} - \frac{\gamma}{\beta}(1-\theta)$$

$$\dot{\theta} = -\beta\phi_I = -\beta\theta + \beta \frac{(1-\rho)\psi'(\theta)}{\langle K \rangle} + \gamma(1-\theta)$$

Final System

We finally have

$$\dot{\theta} = -\beta\theta + \beta \frac{(1-\rho)\psi'(\theta)}{\langle K \rangle} + \gamma(1-\theta)$$
$$\dot{R} = \gamma I \quad S = (1-\rho)N\psi(\theta) \quad I = N - S - R$$

Compare with

$$\dot{\theta} = -\beta\theta + \beta\theta^2 \frac{(1-\rho)\psi'(\theta)}{\langle K \rangle} - \theta\gamma \ln \theta$$
$$\dot{R} = \gamma I, \quad S = (1-\rho)N\psi(\theta), \quad I = N - S - R$$

More details in [1, 2, 3]

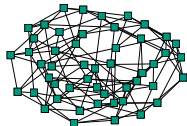
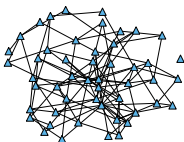
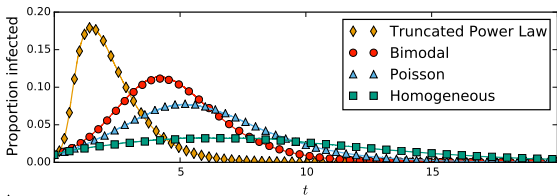
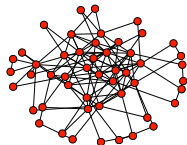
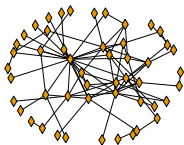

A good exercise

Repeat this derivation for a model in which infections last for one time step and transmission occurs with probability p .

Epidemic probability

- ▶ To calculate epidemic probability, we consider a single introduced node, randomly chosen in the population.

Epidemic probability

- ▶ To calculate epidemic probability, we consider a single introduced node, randomly chosen in the population.
- ▶ $\rho = 0$.

Epidemic probability

- ▶ To calculate epidemic probability, we consider a single introduced node, randomly chosen in the population.
- ▶ $\rho = 0$.
- ▶ $\psi(x) = \sum_k P(k)x^k$ is the probability generating function for the degree distribution.

Calculating epidemic probability

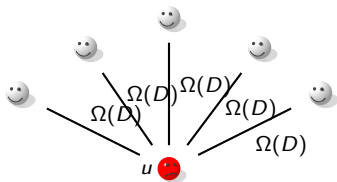

$$\Omega(D) = P(u \text{ does not transmit to a neighbor} | D) + P(u \text{ transmits, but neighbor doesn't lead to an epidemic})$$

Calculating epidemic probability

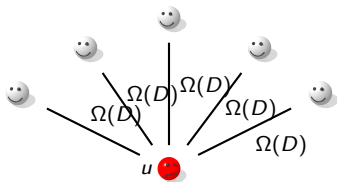

$$\Omega(D) = P(u \text{ does not transmit to a neighbor} | D) + P(u \text{ transmits, but neighbor doesn't lead to an epidemic})$$

Probability a random degree k index case whose infection duration is D does not start an epidemic is

$$\Omega(D)^k$$

Calculating epidemic probability

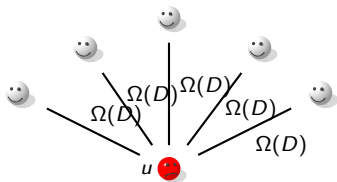

$$\Omega(D) = P(u \text{ does not transmit to a neighbor} | D) + P(u \text{ transmits, but neighbor doesn't lead to an epidemic})$$

Probability a random ~~degree- k~~ index case whose infection duration is D does not start an epidemic is

$$\sum_k P(k) \Omega(D)^k$$

Calculating epidemic probability

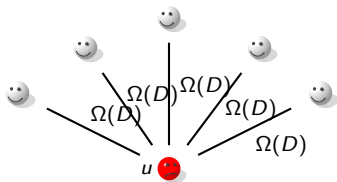

$$\Omega(D) = P(u \text{ does not transmit to a neighbor} | D) + P(u \text{ transmits, but neighbor doesn't lead to an epidemic})$$

Probability a random ~~degree k~~ index case ~~whose infection duration is D~~ does not start an epidemic is

$$1 - \mathcal{P} = \int_0^{\infty} \gamma e^{-\gamma D} \sum_k P(k) \Omega(D)^k dD$$

Calculating epidemic probability

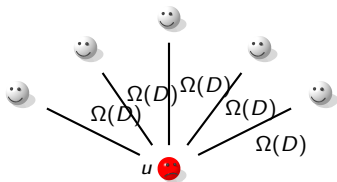

$\Omega(D) = P(u \text{ does not transmit to a neighbor} | D) + P(u \text{ transmits, but neighbor doesn't lead to an epidemic})$

Probability a random ~~degree- k~~ index case ~~whose infection duration is D~~ does not start an epidemic is

$$1 - \mathcal{P} = \int_0^{\infty} \gamma e^{-\gamma D} \sum_k P(k) \Omega(D)^k dD = \int_0^{\infty} \gamma e^{-\gamma D} \psi(\Omega(D)) dD$$

where

$$\psi(x) = \sum_k P(k) x^k$$

Finding Ω

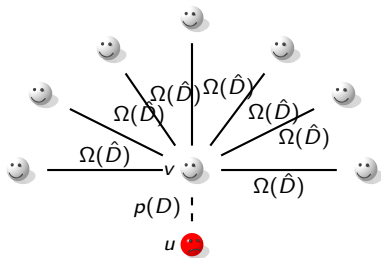

Finding Ω

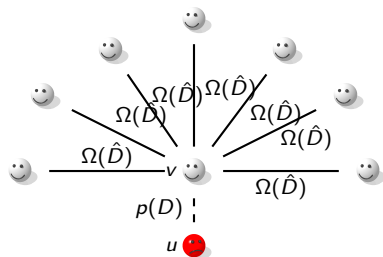

Probability a random partner of the index case having degree \hat{k} whose infection duration is \hat{D} does not start an epidemic is

$$[1 - p(D)] + p(D)\Omega(\hat{D})^{\hat{k}-1}$$

$p(D) = 1 - e^{-\beta D}$ is the probability of transmitting given infection duration of D

Finding Ω

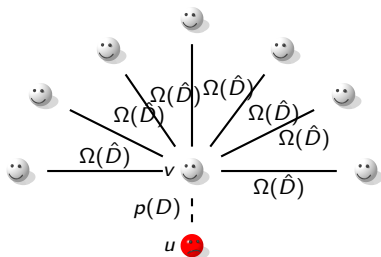

Probability a random partner of the index case ~~having degree \hat{k}~~ whose infection duration is \hat{D} does not start an epidemic is

$$[1 - p(D)] + \sum_{\hat{k}} P_n(\hat{k}) p(D) \Omega(\hat{D})^{\hat{k}-1}$$

$p(D) = 1 - e^{-\beta D}$ is the probability of transmitting given infection duration of D

Finding Ω

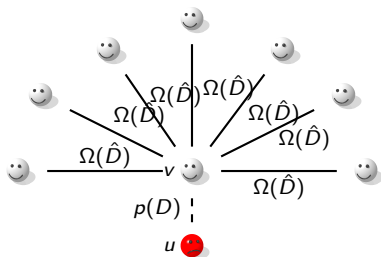

Probability a random partner of the index case ~~having degree \hat{k}~~
~~whose infection duration is \hat{D}~~ does not start an epidemic is

$$\Omega(D) = [1 - p(D)] + \int_0^{\infty} \gamma e^{-\gamma \hat{D}} \sum_{\hat{k}} P_n(\hat{k}) p(D) \Omega(\hat{D})^{\hat{k}-1} d\hat{D}$$

$p(D) = 1 - e^{-\beta D}$ is the probability of transmitting given infection duration of D

Finding Ω

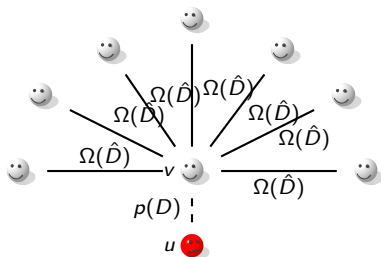

Probability a random partner of the index case ~~having degree \hat{k}~~ ~~whose infection duration is \hat{D}~~ does not start an epidemic is

$$\Omega(D) = [1 - p(D)] + p(D) \int_0^{\infty} \gamma e^{-\gamma \hat{D}} \sum_{\hat{k}} P_n(\hat{k}) \Omega(\hat{D})^{\hat{k}-1} d\hat{D}$$

$p(D) = 1 - e^{-\beta D}$ is the probability of transmitting given infection duration of D

Finding Ω

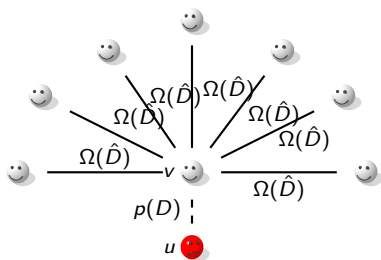

Probability a random partner of the index case ~~having degree \hat{k}~~ ~~whose infection duration is \hat{D}~~ does not start an epidemic is

$$\Omega(D) = [1 - p(D)] + p(D) \int_0^{\infty} \gamma e^{-\gamma \hat{D}} \sum_{\hat{k}} \frac{\hat{k} P(\hat{k})}{\langle K \rangle} \Omega(\hat{D})^{\hat{k}-1} d\hat{D}$$

$p(D) = 1 - e^{-\beta D}$ is the probability of transmitting given infection duration of D

Finding Ω

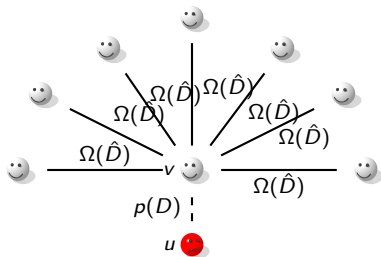

Probability a random partner of the index case ~~having degree \hat{k}~~ ~~whose infection duration is \hat{D}~~ does not start an epidemic is

$$\Omega(D) = [1 - p(D)] + p(D) \int_0^{\infty} \gamma e^{-\gamma \hat{D}} \frac{\sum_{\hat{k}} \hat{k} P(\hat{k}) \Omega(\hat{D})^{\hat{k}-1}}{\langle K \rangle} d\hat{D}$$

$p(D) = 1 - e^{-\beta D}$ is the probability of transmitting given infection duration of D

Finding Ω

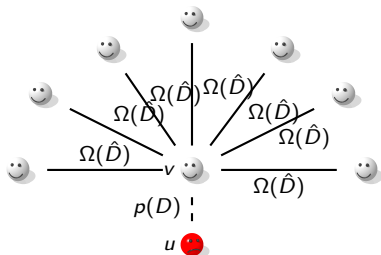

Probability a random partner of the index case ~~having degree \hat{k}~~ ~~whose infection duration is \hat{D}~~ does not start an epidemic is

$$\Omega(D) = [1 - p(D)] + p(D) \int_0^{\infty} \gamma e^{-\gamma \hat{D}} \frac{\psi'(\Omega(\hat{D}))}{\langle K \rangle} d\hat{D}$$

$p(D) = 1 - e^{-\beta D}$ is the probability of transmitting given infection duration of D

Calculating epidemic probability

We arrive at

$$1 - \mathcal{P} = \int_0^{\infty} \gamma e^{-\gamma D} \psi(\Omega(D)) dD$$

$$\Omega(D) = e^{-\beta D} + \left(1 - e^{-\beta D}\right) \int_0^{\infty} \gamma e^{-\gamma \hat{D}} \frac{\psi'(\Omega(\hat{D}))}{\langle K \rangle} d\hat{D}$$

In general we can only solve this numerically, but it is straightforward. We start with a guess that $\Omega(D) = 1$, plug it in and iterate.

In fact the n th iteration will give the probability that the disease spreads at least n generations.

SIR and percolation

SIS disease

References

SIS disease

It is very difficult to write down an analytic model of SIS disease in networks that accounts for partnership duration.

SIS disease

It is very difficult to write down an analytic model of SIS disease in networks that accounts for partnership duration.

- ▶ The difficulty results from the fact that a node can infect its neighbors, thus changing the exposure it receives after it recovers.

SIS disease

It is very difficult to write down an analytic model of SIS disease in networks that accounts for partnership duration.

- ▶ The difficulty results from the fact that a node can infect its neighbors, thus changing the exposure it receives after it recovers.
- ▶ This effect is real: a person who has recovered from, say, MRSA but passed it on to his/her family is at higher risk of reaquiring MRSA. Ignoring this weakens our ability to draw conclusions.

SIS disease

It is very difficult to write down an analytic model of SIS disease in networks that accounts for partnership duration.

- ▶ The difficulty results from the fact that a node can infect its neighbors, thus changing the exposure it receives after it recovers.
- ▶ This effect is real: a person who has recovered from, say, MRSA but passed it on to his/her family is at higher risk of reaquiring MRSA. Ignoring this weakens our ability to draw conclusions.
- ▶ This has policy implications: how much will it reduce MRSA transmission if we clear the disease from a hospital or a prison?

SIS disease

It is very difficult to write down an analytic model of SIS disease in networks that accounts for partnership duration.

- ▶ The difficulty results from the fact that a node can infect its neighbors, thus changing the exposure it receives after it recovers.
- ▶ This effect is real: a person who has recovered from, say, MRSA but passed it on to his/her family is at higher risk of reaquiring MRSA. Ignoring this weakens our ability to draw conclusions.
- ▶ This has policy implications: how much will it reduce MRSA transmission if we clear the disease from a hospital or a prison?
- ▶ So for SIS disease simulation is likely to play a major role.

Percolation-like results and SIS

- ▶ It is possible to use percolation-like results to for rigorous conclusions about SIS disease.

Percolation-like results and SIS

- ▶ It is possible to use percolation-like results to for rigorous conclusions about SIS disease.
- ▶ As a general rule, these rigorous results do not generalize if we do not assume constant infection and transmission rates.

A percolation-like approach

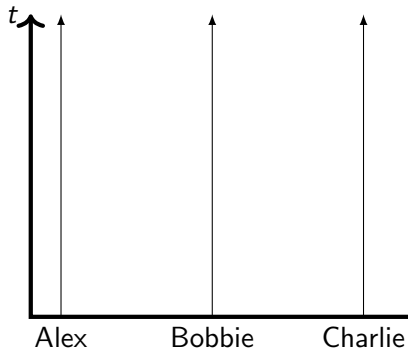

A percolation-like approach

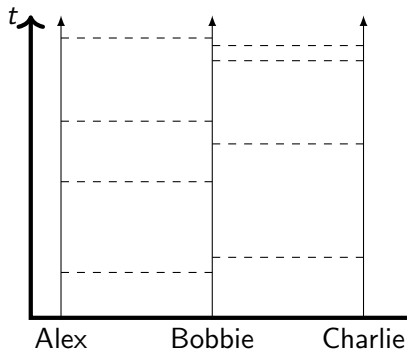

- ▶ Find transmission events as Poisson process

A percolation-like approach

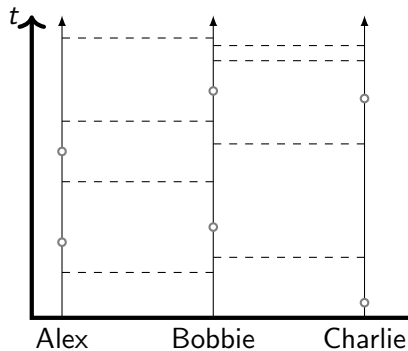

- ▶ Find transmission events as Poisson process
- ▶ Find recovery events as Poisson process

A percolation-like approach

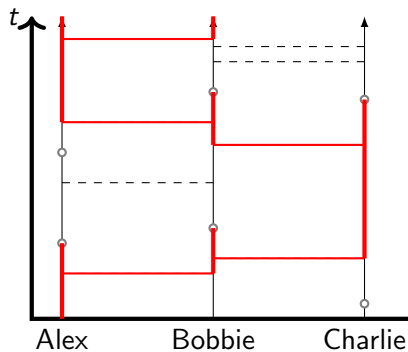

- ▶ Find transmission events as Poisson process
- ▶ Find recovery events as Poisson process
- ▶ Trace out from initial infection

Now invert the picture

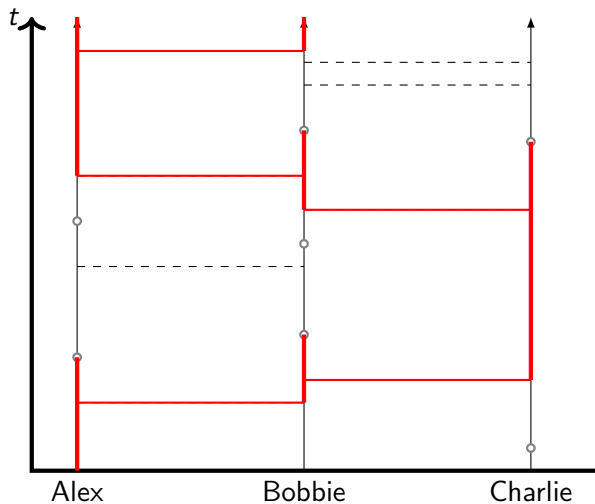

Now invert the picture

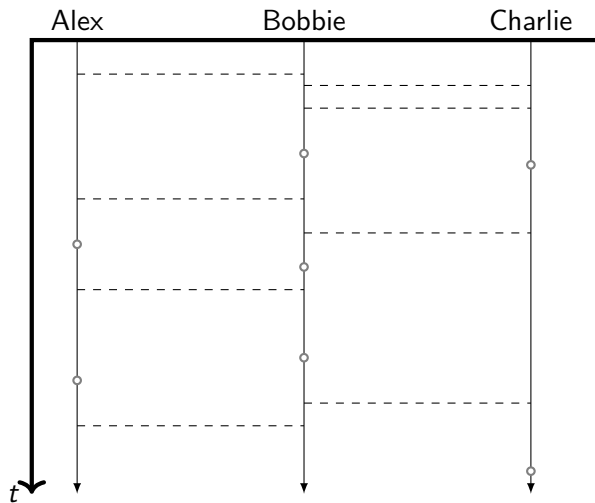

Now invert the picture

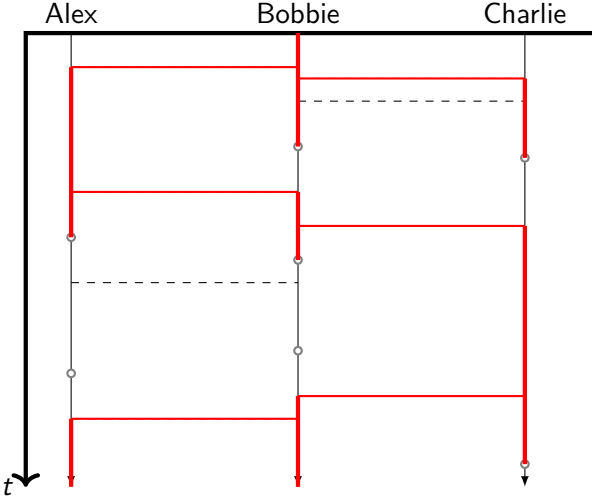

Some conclusions

- ▶ An infection of u at time 0 leads to an infection of v at time t iff there is a path that doesn't go through a recovery event.

Some conclusions

- ▶ An infection of u at time 0 leads to an infection of v at time t iff there is a path that doesn't go through a recovery event.
- ▶ That reversed path also works. So any node infected at time t would cause infection of the initial node at time 0 in the reversed process.

Some conclusions

- ▶ An infection of u at time 0 leads to an infection of v at time t iff there is a path that doesn't go through a recovery event.
- ▶ That reversed path also works. So any node infected at time t would cause infection of the initial node at time 0 in the reversed process.
- ▶ So the expected number of nodes infected at time t starting from infection of u at time 0 is equal to the probability u is infected at time t if we infect a random individual at time 0.

Some conclusions

- ▶ An infection of u at time 0 leads to an infection of v at time t iff there is a path that doesn't go through a recovery event.
- ▶ That reversed path also works. So any node infected at time t would cause infection of the initial node at time 0 in the reversed process.
- ▶ So the expected number of nodes infected at time t starting from infection of u at time 0 is equal to the probability u is infected at time t if we infect a random individual at time 0.
- ▶ The equilibrium size of an SIS epidemic with Poissonian transmission and recovery equals the probability that an epidemic occurs.

SIS size vs Probability

1000 simulations starting with a single randomly chosen node in a Configuration model network with $P(1) = P(5) = 0.5$.

SIS size vs Probability

1000 simulations starting with a single randomly chosen node in a Configuration model network with $P(1) = P(5) = 0.5$.

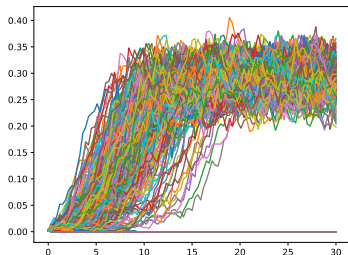

$\beta = 0.5, \gamma = 1$
273 did not die out

SIS size vs Probability

1000 simulations starting with a single randomly chosen node in a Configuration model network with $P(1) = P(5) = 0.5$.

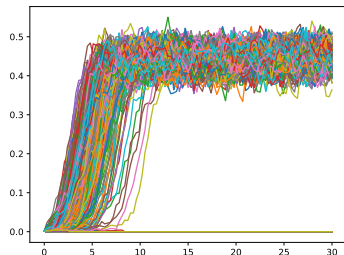

$\beta = 0.75, \gamma = 1$
448 did not die out

SIS size vs Probability

1000 simulations starting with a single randomly chosen node in a Configuration model network with $P(1) = P(5) = 0.5$.

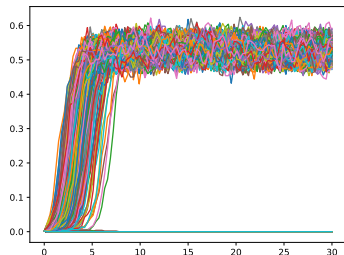

$\beta = 1, \gamma = 1$
537 did not die out

SIR and percolation

SIS disease

References

References I

- [1] Joel C. Miller, Anja C. Slim, and Erik M. Volz.
Edge-based compartmental modelling for infectious disease spread.
[Journal of the Royal Society Interface](#), 9(70):890–906, 2012.
- [2] Joel C. Miller.
Epidemics on networks with large initial conditions or changing structure.
[PLoS ONE](#), 9(7):e101421, 2014.
- [3] Istvan Z Kiss, Joel C Miller, and Péter L Simon.
[Mathematics of epidemics on networks: from exact to approximate models.](#)
IAM. Springer, 2017.